

Compressed air meter DN 65-250

testo 6456



Flexible:

Suitable for large pipe diameters DN 65 - 250

Clear overview:

Direct compressed air monitoring with simultaneous display of three measurement values thanks to TFT display as standard

Best system integration:

Dual analog, or pulse and analog output

Optional:

With built-in pressure measurement (with output option F02)

Four measurement parameters, one instrument:

Flow rate, totaliser, temperature and pressure (with output option F02)

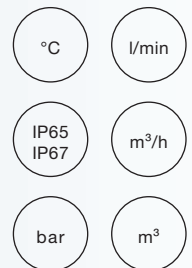

The testo 6456 compressed air meter is used for the recording, monitoring and reporting of compressed air consumption, and thereby for the detection of leaks in compressed air systems, cost allocation according to consumption and peak load management.

The testo 6457 compressed air meter records the standard volumetric flow of working compressed air according to the calorimetric principle, which means that the measurement method is independent of the process pressure and does not cause any permanent loss of pressure.

Technical data

		DN 65 (2 ½")	DN 80 (3")	DN 100 (4")	DN 125 (5")	DN 150 (6")	DN 200 (8")	DN 250 (10")
Measuring/adjustment range for flow-through								
Measuring range	l/min m/s m³/h	139 to 33,510 0.6 to 143 9 to 2,011	192 to 46,150 0.6 to 143 12 to 2,769	324 to 77,780 0.6 to 143 20 to 4,667	490 to 117,600 0.6 to 143 30 to 7,057	717 to 172,100 0.6 to 143 43 to 10,320	1,215 to 291,400 0.6 to 143 73 to 17,480	1,917 to 459,800 0.6 to 143 115 to 27,590
Temperature coefficient	±0.07% of measured value							
Accuracy (measuring range)	Class 151: ± (3 % m.v. + 0.3 % FS value);							
Repeat accuracy	±1.5 % of measured value							
Display range	0 to 120 % FS value							
Resolution	l/min m³/h	0.8 0.04	1.05 0.005	1.78 0.009	2.7 0.013	3.9 0.02	6.7 0.033	10.5 0.053
Low flow cut-off LFC	Configurable by user. Factory setting 0.13 % of f.v.							
Measuring/adjustment range for flow-through quantity								
Measuring range	0 to 100,000,000 m³ 0 to 353,146,667.2 scf							
Display range	0 to 100,000,000 m³ 0 to 353,146,667.2 scf							
Measuring/adjustment range for pressure (only with output option F02)¹								
Measuring range	-1 to 16 bar							
Display range	-1 to 20 bar							
Resolution	0.05 bar							
Measuring/adjustment range for temperature								
Measuring range	-10 to +60 °C/+14 to +140 °F							
Display range	-24 to +74 °C/-11.2 to +165.2 °F							
Resolution	0.2 °C / 0.5 °F							
Field of application								
Media	Working compressed air							
Medium temperature	-10 to +60 °C/+14 to +140 °F							
Pressure resistance	16 bar (> DN200 14 bar)							
Electrical data								
Operating voltage	18 to 30 VDC (acc. to EN 50178 SELV/PELV)							
Current consumption	< 80 mA							
Protection class	III							
Protected against polarity reversal	Yes							
Outputs²	F01				F02			
Output signal	OUT1: Pulse, switching signal OUT2: Analog signal, pulse, switching signal				OUT1: Analog signal OUT2: Analog signal			
Standard configuration	OUT1: Pulse (flow rate) OUT2: Analog signal (flow rate)				OUT1: Analog signal (pressure) OUT2: Analog signal (flow rate)			
Number of outputs	2							
Analog output current	4 to 20 mA (scalable)							
Max. current load	< 150 mA							
Pulse voltage	VDC - 2 V							
Pulse length	0.002 to 2s (depending on pulse value)							
Max. load	500 Ω							
Short circuit protection	Yes							
Temperature monitoring								
Accuracy	± 0.5 K; (for media flow within the limits of the flow measuring range)							

¹ Pressure measurement is only possible in conjunction with the KMAT specification F02 (dual analog instrument)

² The output option (F01/F02) is specified when ordering and cannot be changed later.

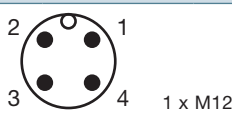
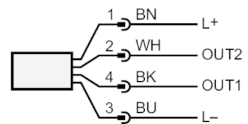
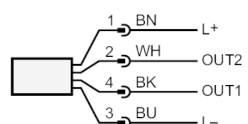
	DN 65 (2 1/2")	DN 80 (3")	DN 100 (4")	DN 125 (5")	DN 150 (6")	DN 200 (8")	DN 250 (10")
Reaction times							
Response time	0.1 s; (dAP = 0)						
Temperature monitoring							
Response dynamic	t ₀₉ = 0.5 s						
Ambient conditions							
Ambient temperature	0 to +60 °C						
Storage temperature	-20 to +85 °C						
Humidity	max. permitted relative humidity < 90 %						
Protection class	IP 65; IP 67						
Approvals / tests							
EMC	DIN EN 60947-5-9						
Vibration resistance	DIN EN 68000-2-6 5 g (10 to 2,000 Hz)						
Mechanical data							
Housing material	PBT-GF 20, PC (APEC), PBT-PC-GF 30; PPS GF 40; FKM						
Media contact	Materials stainless steel or steel zinc-coated, FKM, PPS GF40, Al2O3 (ceramic), acrylate, glass-coated ceramics						
Measurement stretch length	124 mm	160 mm	160 mm	172 mm	180 mm	180 mm	196 mm
Pipe diameter (measurement stretch)	DN 65 (2 1/2")	DN 80 (3")	DN 100 (4")	DN 125 (5")	DN 150 (6")	DN 200 (8")	DN 250 (10")
Weight testo 6456 (steel zinc-coated/stainless steel)	8.5 g	10.6 g	12.8 g	20.6 g	26.2 g	36.6 g	55.1 g
Display / control elements							
Display	Colour display - 1.44" pixel resolution - 128 x 128						
Comments	m.v. = measurement value f.s = full scale value Measurement, display and adjustment ranges refer to standard volumetric flow according to DIN ISO 2533. Please see the instruction manual for information on installation and operation.						
Electrical connection							
Plug-in connection							
Outputs (with specification F01)							
Connections		1 – Supply connection 18 to 30 VDC (+) 2 – OUT2: Analog signal, pulse, switching signal 4 – OUT1: Pulse, switching signal 3 – Supply connection GND (-)	brown white black Blue				
Outputs (with specification F02)							
Connections		1 – Supply connection 18 to 30 VDC (+) 2 – OUT2: Analog signal 4 – OUT1: Analog signal 3 – Supply connection GND (-)	brown white black Blue				

Technical drawings

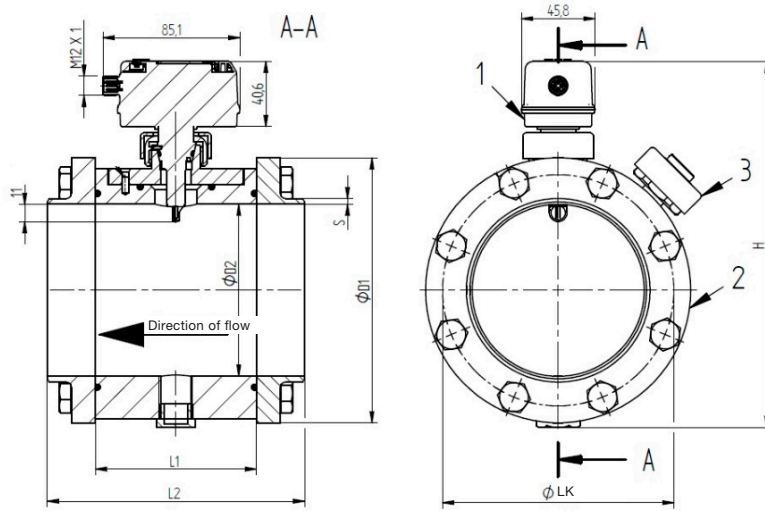

Order no.	KMAT ϕ D0x (steel) / D1x (stainless steel)	Inch	DN	L1 mm	L2 mm	ϕ D1 mm	ϕ D2 mm	S mm	H1 mm	N	ϕ DL mm	ϕ LK mm
0555 6456	D01 / D11	2½"	65	104	148	125	70.3	2.9	195	16xM12	13	106
0555 6456	D02 / D12	3"	80	100	160	141	82.5	3.2	210	16xM12	13	118
0555 6456	D03 / D13	4"	100	100	160	165	107.1	3.6	235	16xM12	13	144
0555 6456	D04 / D14	5"	125	100	172	205	131.7	4	267	24xM12	13	168
0555 6456	D05 / D15	6"	150	100	180	235	159.3	4.5	296	16xM12	17	200
0555 6456	D06 / D16	8"	200	100	180	290	207.3	5.9	348	24xM12	17	252
0555 6456	D07 / D17	10"	250	100	196	355	260.4	6.3	408	24xM12	21	315

Order data

Axx	Material
Bxx	Measurement medium
Cxx	Quick-release connection yes/no
Dxx	Diameter
Exx	Standard reference
Fxx	Output
Gxx	LABS-free yes/no

Axx Material

- A01 Material steel zinc-coated
- A02 Material stainless steel

Bxx Measurement medium

- B01 Measurement medium (air)
- B02 Measurement medium (nitrogen)
- B03 Measurement medium (CO₂)
- B04 Measurement medium (argon)

Cxx Quick-release connection yes/no

- C01 without additional quick-release connection
- C02 with additional quick-release connection

Dxx Diameter

- D01 DN65 (steel zinc-coated)
- D02 DN80 (steel zinc-coated)
- D03 DN100 (steel zinc-coated)
- D04 DN125 (steel zinc-coated)
- D05 DN150 (steel zinc-coated)
- D06 DN200 (steel zinc-coated)
- D07 DN250 (steel zinc-coated)
- D11 DN65 (stainless steel)
- D12 DN80 (stainless steel)
- D13 DN100 (stainless steel)
- D14 DN125 (stainless steel)
- D15 DN150 (stainless steel)
- D16 DN200 (stainless steel)
- D17 DN250 (stainless steel)

Exx Standard reference

- E01 Standard reference (15 °C / 1013 mbar)
- E02 Standard reference (0 °C / 1013 mbar)
- E03 Standard reference (20 °C / 1000 mbar)

Fxx Output

- F01 OUT 1: Pulse (flow rate), OUT 2: Analog (flow rate)
- F02 OUT 1: Analog (pressure), OUT 2: Analog (flow rate)

Gxx LABS-free yes/no

- G01 without LABS-free cleaning
- G02 with LABS-free cleaning

Order example

Order code for compressed air meter testo 6456 with following options:

- Steel zinc-coated
- Measurement medium (air)
- with additional quick-release connection, e.g. for testo 6740
- Diameter DN100
- Standard reference (15 °C / 1013 mbar)
- OUT 1: Pulse, OUT 2: Analog
- without LABS-free cleaning

—> **0555 6456 A01 B01 C02 D03 E01 F01 G01**

Accessories

Connection cable		Order no. 0699 3393
	Connections	1 Supply connection 18 to 30 VDC (+) 2 Analog output pressure, temperature, or flow-through (4 to 20 mA) 4 Analog output pressure, temperature, or flow-through (4 to 20 mA) 3 Supply connection GND (-) brown white black Blue
	Cable length	5 metres
	Plug-in connection	M12 plug connection

Mains unit (desktop appliance)		Order no. 0554 1748
	Input	110 to 240 VDC
	Output	24 VDC/ 350 mA

Mains unit (top-hat rail mounting)		Order no. 0554 1749
	Input	85 to 264 VAC 110 to 300 VDC
	Output	24 VDC/ 2.5 A

Welding flange	Order no.
Compac flange DN65 (steel zinc-coated)	0554 6401
Compac flange DN80 (steel zinc-coated)	0554 6402
Compac flange DN100 (steel zinc-coated)	0554 6403
Compac flange DN125 (steel zinc-coated)	0554 6404
Compac flange DN150 (steel zinc-coated)	0554 6405
Compac flange DN200 (steel zinc-coated)	0554 6406
Compac flange DN250 (steel zinc-coated)	0554 6407
Compac flange DN65 (stainless steel)	0554 6411
Compac flange DN80 (stainless steel)	0554 6412
Compac flange DN100 (stainless steel)	0554 6413
Compac flange DN125 (stainless steel)	0554 6414
Compac flange DN150 (stainless steel)	0554 6415
Compac flange DN200 (stainless steel)	0554 6416
Compac flange DN250 (stainless steel)	0554 6417

Protective cap	Order no.
Blind plug/protective cap for testo 6456 and testo 6457	0554 6431